 Um zu vermeiden, dass die Fahrzeuginsassen unnötig elektromagnetischen Feldern ausgesetzt werden, muss ein Abstand zwischen dem Steuergerät und den Fahrzeuginsassen von mind. 0,25 m eingehalten werden.

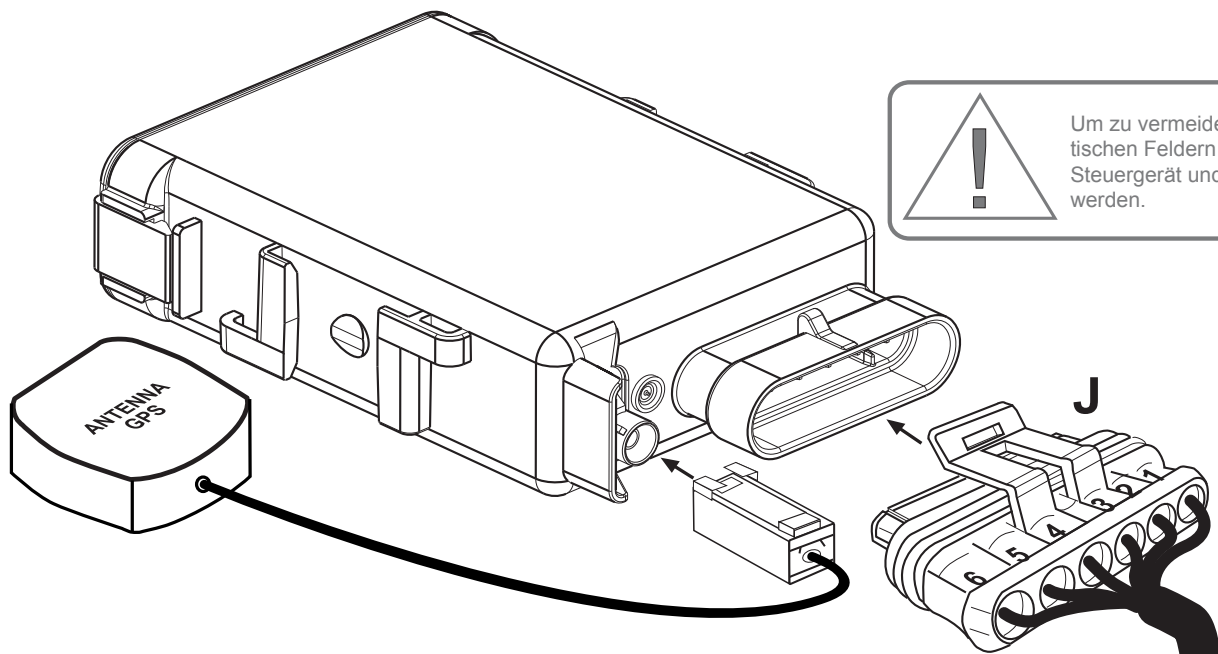
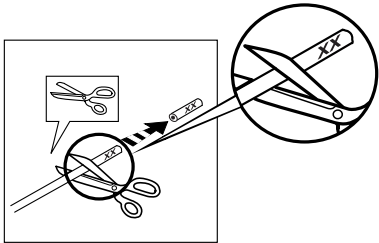

Paniktaster (optional)

Negativer Eingang

J-1 Schwarz „1“

Schwarz „6“ J-6 Negativer Ausgang

 Nicht wasserfest!

24V Relais als Zubehör erhältlich

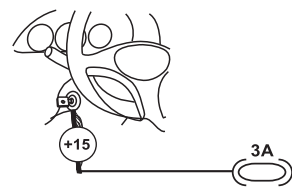
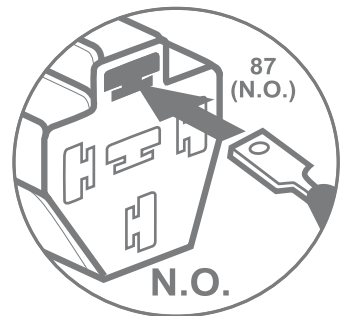

J-2 Schwarz „2“

J-2 Schwarz „2“

STARTER +50



Anlasserunterbrechung

STARTER +50



min 0,5A
15A permanent
30A (6 Sek.)

Anlasserunterbrechung

+30

Schwarz „4“ J-4

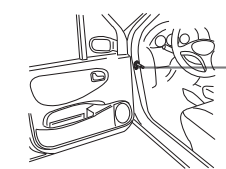
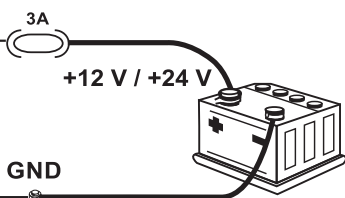

Türkontakte

J-3 Schwarz „3“

Schwarz „5“ J-5